

EXTERIOR DOORS

TRADITION
RELIABILITY
SECURITY



The mark of
responsible forestry
Look for FSC® certified products

ERKADO
YOUR DOORS - YOUR HOUSE

EDITION: I/2016

WOODEN EXTERIOR, P' DOORS



ERKADO is the example of a success of family business on the global market. Very **dynamic** and determined development of production potential cause that more and more often You open... **ERKADO** doors.

ERKADO is the manufacturer of exterior and interior doors with 40-year old tradition. It is the trademark that has embraced wholesale and export sales since 2010. The characteristic assets presented by **ERKADO** are: numerous and continuous investments [purchase of robots, new dedicated production lines, modern hardware and machinery], mastering and developing technologies [**SOFT, STILE, TWIN, BOARD**], delivering and launching modern technical solutions [wide variety of sliding systems], expanding the factory by constructing new warehouses and creating new production space.

The strong expansion and steady growth make **ERKADO** one of the market leaders in the manufacture of doors benchmarking the brand as the leader of high quality doors at reasonable price.

As one of the leaders in the branch, the company also takes up numerous initiatives and supports charities as well as individuals. The policy we truly believe in is – **Satisfaction – Innovation – Product – Price**.

BOARD TECHNOLOGY DOORS

The key feature of board technology used for all P-type doors is to employ the advanced production technology.

This technology allows for preserving the beauty of wooden doors and decors, eliminating at the same time majority of problems occurring when applying traditional technologies, these problems are: cracking and moving door coffers, door leaf buckling, uneven colouring of particular door elements, fissuring and veneer waviness as well as problems with joint fillers.

ATTENTION!

- All wood devoted to veneer differ between one another in terms of colour, tint, structure and texture. Such vast differences may occur even among one type of wood and these are the characteristics of natural wood and therefore they cannot be the basis for complaint.
- Individual colour of wood and thickness of surface lacquer have great influence on the final colour of the transparent layer [varnish]
- Presented colours are only of demonstrative character and cannot be treated as the target colour sample
- Due to negative influence of sunlight as well as rain water on all sorts of varnished surfaces it is recommended to apply roofing over the exterior door preferably by constructing open vestibule.

EXEMPLARY COLOURS ON MERANTI WOOD

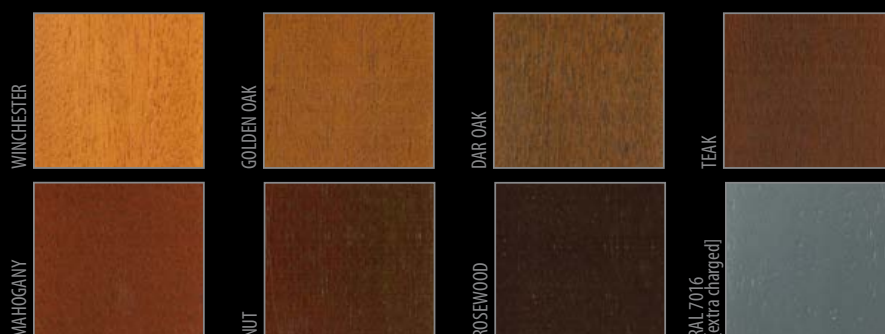

Classic RAL COLOUR PALETTE

TECHNICAL PARAMETRES

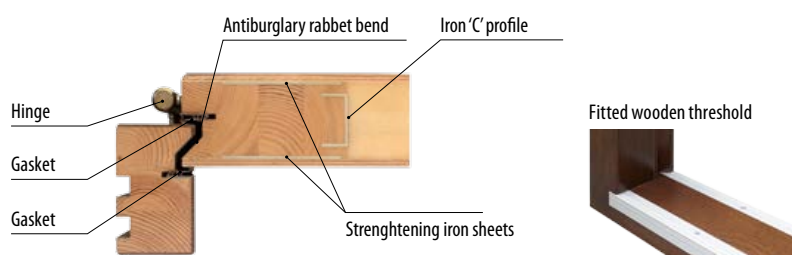
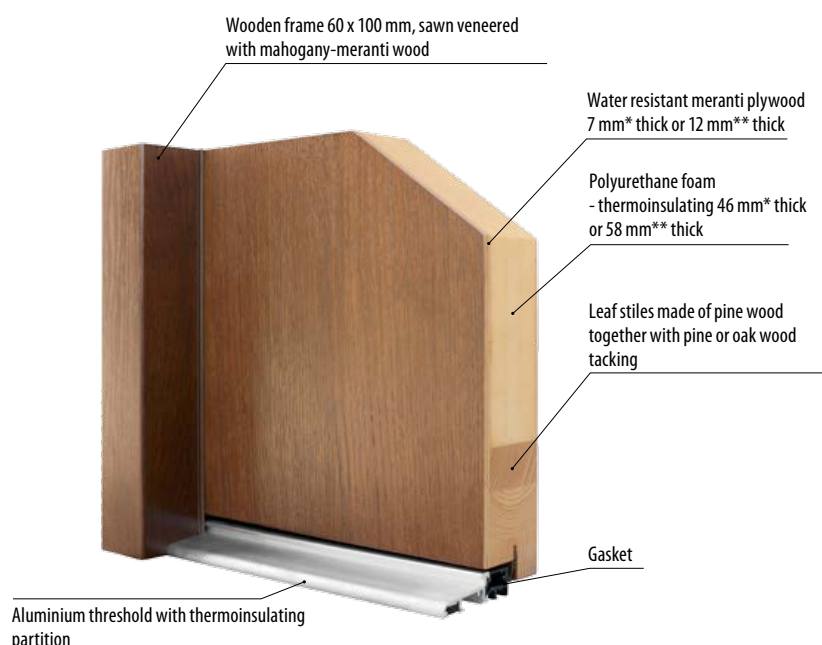

Technical description - door leaf 72 mm

- **Thermal permeability ratio** $U_d < 1,20 \text{ W/m}^2\text{K}$
- **Material:** oak, pine or meranti
- **Construction**
 - door thickness 72 mm
 - gasket fixed in door leaf and frame
 - rebated door leaf
 - external sheathing made of watertight oak, pine or meranti plywood of thickness 12 mm [mahogany-meranti], 7 mm and 12 mm [oak or pine]
 - internal grating with polyurethane foam 58 mm thick [7 mm plywood] and 48 mm thick [12 mm plywood]
 - door stile made of pine wood and strengthened with 'C' profile
 - rabbet bend from the hinge side
- **Frame**
 - wood layer-glued together with oak or pine tacking with dimensions 100 mm x 60 mm
 - wooden threshold or aluminium threshold with thermal partition
- **Finishing**
 - triple hydrodynamic coating with water-thinnable paints according to ERKADO palette of colours or RAL colours [extra charged], except RAL 9016 [white] and RAL 70-16 [charcoal] - page 36
- **Dimensions**
 - standard according to the table [p. 35]
 - individual at extra charge
- **Fittings in standard**
 - 2 independent pin mortise locks, lock **distance 72 mm**
 - four hinges regulated in three planes
 - glass set REFLEX BROWN 44 mm thick [two-chambered] for models: P3, P4, P5, P6, P12, P13, P14, P16, P19, P21, P23, P24, P25, P28, P29, P30, P31, P33, P34, P36, P37, P39, P40, P45, P49, P51, P52, P53, P96, P102, P93, P108, P109, P111, P112, P113, P114, P115, P116, P117, P118
 - glass set REFLEX BROWN 54 mm thick [two-chambered] for models: P7, P8, P9, P10, P20, P22, P26, P27, P32, P41, P47, P50, P54, P55, P60, P61, P62, P63, P64, P65, P67, P69, P71, P72, P73, P74, P75, P76, P77, P78, P79, P80, P81, P82, P83, P92, P94, P95, P97, P99, P100, P101, P103, P104, P105, P106, P107, P119
 - glass set REFLEX BROWN 70 mm thick [three-chambered] for models: P42, P44, P48, P56, P57, P60, P66, P68, P70, P98
 - wooden threshold or aluminium threshold with thermal partition
 - decorative stainless iron sheets for models: P42, P44, P46, P48, P57, P58, P66, P68, P70, P81, P95, P97, P98, P99, P100, P101, P102, P103, P104, P105, P106

■ Fittings additionally charged

- door knob
- cylinders 35/65
- door holder
- bio-metric lock
- peephole
- electric strike
- multi-point door lock with one or two cylinders
- gutter drip (doors opening inside)

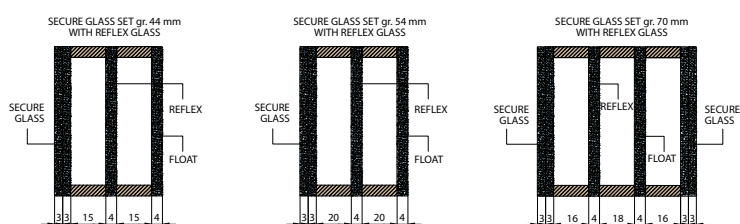

- 7 mm* models: P7, P8, P9, P10, P20, P22, P26, P27, P32, P41, P42, P44, P46, P47, P48, P50, P54, P55, P57, P58, P60, P61, P62, P63, P64, P65, P66, P67, P68, P69, P70, P71, P72, P73, P74, P75, P76, P77, P78, P79, P80, P81, P82, P92, P94, P95, P97, P99, P100, P101, P103, P104, P105, P106, P119
- 12 mm* models: P1, P3, P4, P5, P6, P12, P13, P14, P16, P19, P21, P23, P24, P25, P28, P29, P30, P31, P33, P34, P36, P37, P39, P40, P45, P49, P51, P52, P53, P96, P102, P93, P108, P109, P111, P112, P113, P114, P115, P116, P117, P118

* change of glazing for milk, sanded glass or two-way mirror: fixed charge

TECHNICAL PARAMETRES

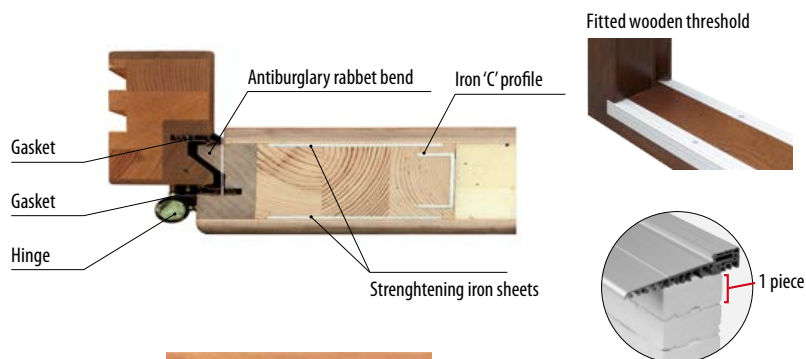
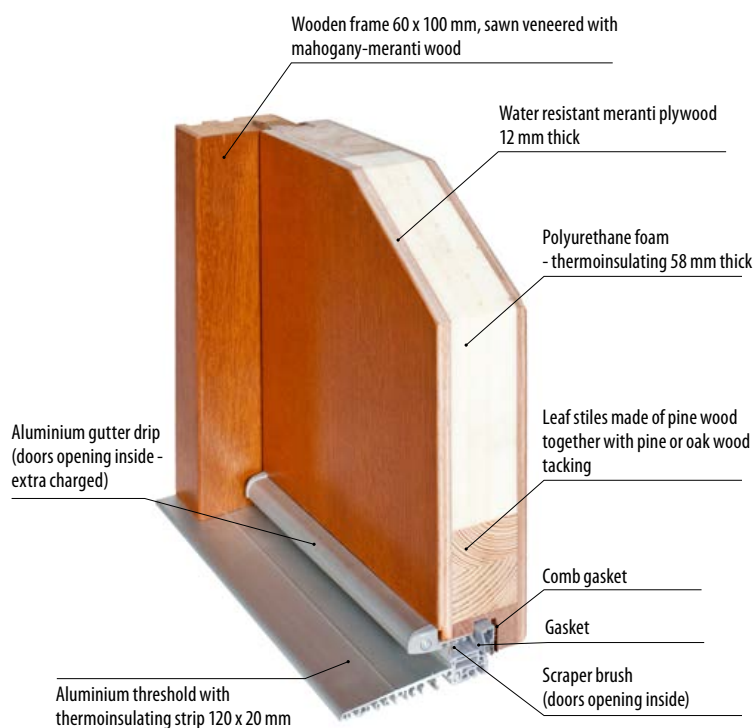

thermoinsulating strip
H: 30 mm x W: 64 mm
— extra charged

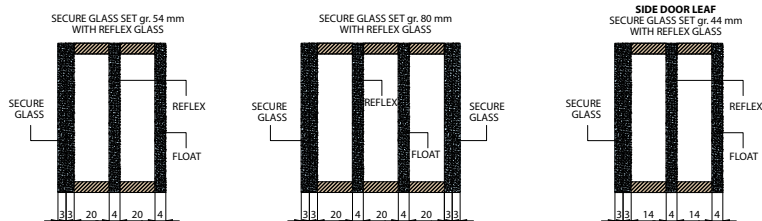

Technical description - door leaf 82 mm

■ **Thermal permeability ratio $U_d < 0,9 \text{ W/m}^2\text{K}$**

■ **Material: meranti, oak or pine**

■ **Construction**

- door thickness 82 mm
- gasket fixed in door leaf and frame
- rebated door leaf
- external sheathing made of watertight mahogany meranti plywood oak or pine plywood of thickness 12 mm [mahogany-meranti], 7 mm and 12 mm [oak or pine]
- internal grating with polyurethane foam 58 mm thick
- door stile made of pine meranti wood and strenghtened with 'C' profile
- rabbet bend from the hinge side

■ **Frame**

- wood layer-glued together with mahogany meranti tacking with dimensions 100 mm x 60 mm
- wooden threshold or aluminium threshold with thermal partition

■ **Finishing**

- triple hydrodynamic coating with water-thinnable paints according to ERKADO palette of colours or RAL colours [extra charged], except RAL 9016 [white] and RAL 70-16 [charcoal] - page 36

■ **Dimensions**

- standard according to the table [p. 35]
- individual at extra charge

■ **Fittings in standard**

- multi-point lock with 1 cylinder, lock **distance 72 mm**
- four hinges regulated in three planes
- glass set REFLEX BROWN 54 mm thick [two-chambered] P3, P4, P5, P6, P12, P13, P14, P16, P19, P21, P23, P24, P25, P28, P29, P30, P31, P33, P34, P36, P37, P39, P40, P45, P49, P51, P52, P53, P96, P102, P93, P108, P109, P111, P112, P113, P114, P115, P116, P117, P118
- glass set REFLEX BROWN 64 mm thick [two-chambered] for models: P7, P8, P9, P10, P20, P22, P26, P27, P32, P41, P47, P50, P54, P55, P60, P61, P62, P63, P64, P65, P67, P69, P71, P72, P73, P74, P75, P76, P77, P78, P79, P80, P81, P82, P83, P92, P94, P95, P97, P99, P100, P101, P103, P104, P105, P106, P107, P119
- glass set REFLEX BROWN 80 mm thick [three-chambered] for models: P42, P44, P48, P56, P57, P60, P66, P68, P70, P98
- aluminium threshold with thermal partition
- decorative stainless iron sheets for models: P42, P44, P46, P48, P57, P58, P60, P66, P68, P70, P81, P95, P97, P98, P99, P100, P101, P102, P103, P104, P105, P106

■ **Fittings additionally charged**

- door knob
- cylinders 45/65
- door holder
- bio-metric lock
- peephole
- electric strike
- multi-point door lock with one or two cylinders
- gutter drip (doors opening inside)

* change of glazing for milk, sanded glass or two-way mirror: fixed charge

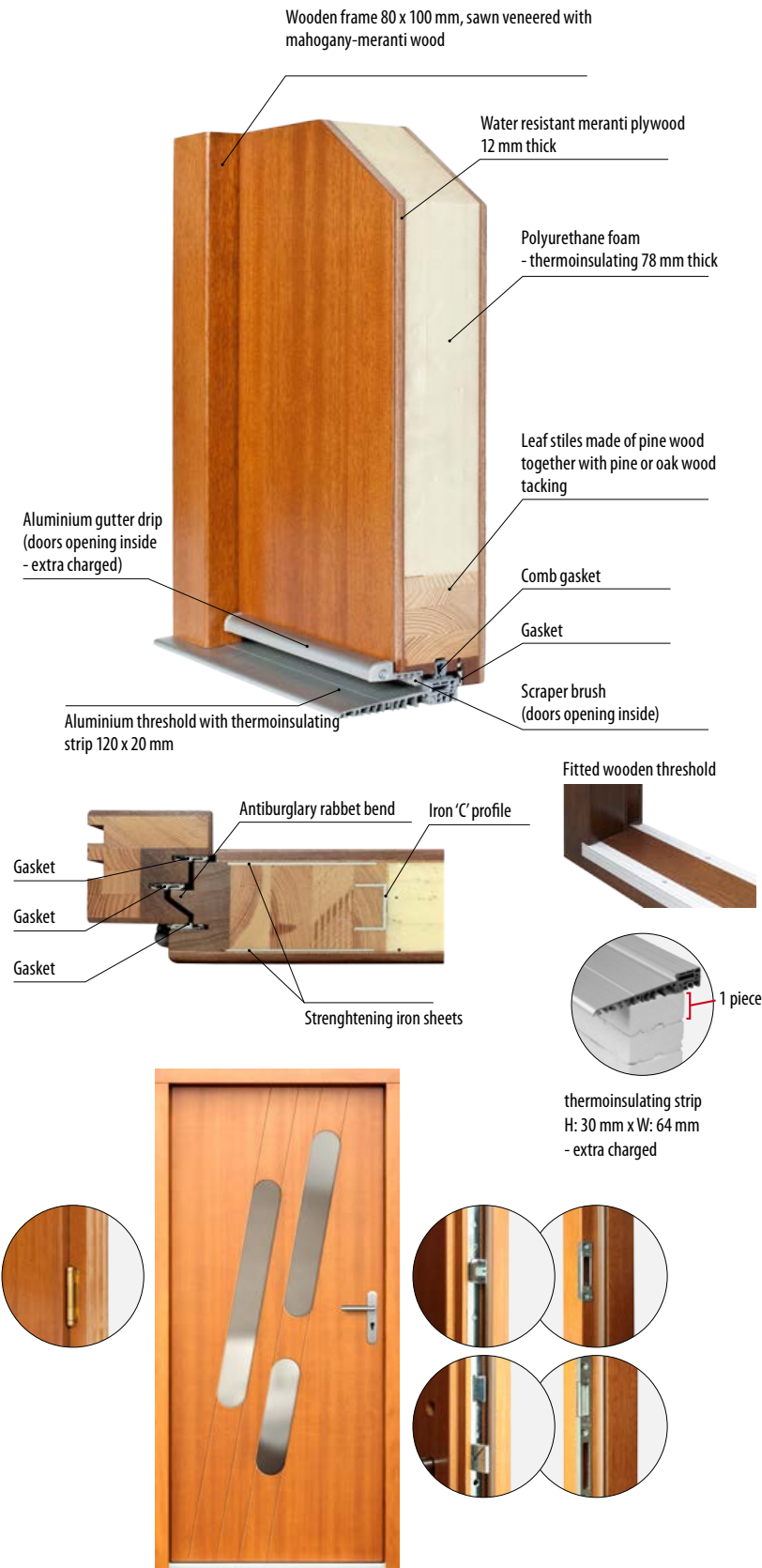

Technical description - door leaf 102 mm

■ Thermal permeability ratio $U_d = 0,75 \text{ W/m}^2\text{K}$

■ Material: meranti or oak

■ Construction

- door thickness 102 mm
- gasket fixed in door leaf and frame
- rebated door leaf
- external sheathing made of watertight mahogany meranti plywood oak or pine plywood of thickness 12 mm [mahogany-meranti], 7 mm and 12 mm [oak or pine]
- internal grating with polyurethane foam 78 mm thick
- door stile made of pine meranti wood and strengthened with 'C' profile
- rabbet bend from the hinge side

■ Frame

- wood layer-glued together with mahogany meranti tacking with dimensions 100 mm x 80 mm
- wooden threshold or aluminium threshold with thermal partition

■ Finishing

- triple hydrodynamic coating with water-thinnable paints according to ERKADO palette of colours or RAL colours [extra charged], except RAL 9016 [white] and RAL 70-16 [charcoal] - page 36

■ Dimensions

- standard according to the table [p. 35]
- individual at extra charge

■ Fittings in standard

- multi-point lock with 1 cylinder, lock distance 92 mm
- three hinges regulated in three planes - 3D
- glass set REFLEX BROWN 72 mm thick [three-chambered]
- glass set REFLEX BROWN 100 mm thick [four-chambered] for models: P42, P44, P48, P57, P66, P68, P70, P98
- aluminium threshold with thermal partition
- decorative stainless iron sheets for models: P42, P44, P46, P48, P57, P58, P66, P68, P70, P81, P82, P95, P97, P98, P99, P100, P101, P102, P103, P104, P105, P106

■ Fittings additionally charged

- door knob
- cylinders 60/65
- door holder
- bio-metric lock
- peephole
- electric strike
- multi-point door lock with one or two cylinders
- gutter drip (doors opening inside)

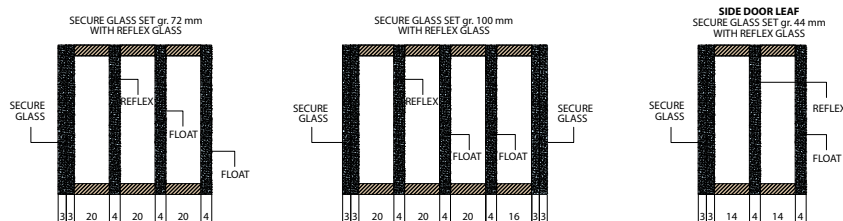

* change of glazing for milk, sanded glass or two-way mirror: fixed charge

LIST OF MODELS



P1 – page 27



P2 – page 27



P3 – page 26



P4 – page 27



P5 – page 26



P6 – page 25



P7 – page 23



P8 – page 18



P9 – page 18



P10 – page 18



P11 – page 27



P12 – page 25



P13 – page 25



P14 – page 25



P15 – page 27



P16 – page 26



P17 – page 28



P18 – page 28



P19 – page 22



P20 – page 20



P21 – page 18



P22 – page 24



P23 – page 21



P24 – page 19



P25 – page 19



P26 – page 25



P27 – page 25



P28 – page 19



P29 – page 22



P30 – page 21



P31 – page 24



P32 – page 22



P33 – page 26



P34 – page 24



P35 – page 27



P36 – page 22



P37 – page 18



P38 – page 28



P39 – page 21



P40 – page 19



P41 – page 22



P42 – page 12



P44 – page 13



P45 – page 26



P46 – page 15



P47 – page 18



P48 – page 12



P49 – page 21



P50 – page 26



P51 – page 21



P52 – page 21



P53 – page 22



P54 – page 24



P55 – page 23



P56 – page 16



P57 – page 12



P58 – page 16



P59 – page 28



P60 – page 13



P61 – page 17



P62 – page 17



P63 – page 20



P64 – page 16



P65 – page 20



P66 – page 14



P67 – page 20



P68 – page 13



P69 – page 23



P70 – page 12



P71 – page 23

LIST OF MODELS



P72 – page 19



P73 – page 17



P74 – page 17



P75 – page 17



P76 – page 17



P77 – page 20



P78 – page 24



P79 – page 20



P80 – page 24

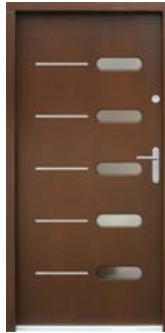

P81 – page 13



P82 – page 15



P83 – page 16



P84 – page 16



P85 – page 29



P86 – page 29



P87 – page 29

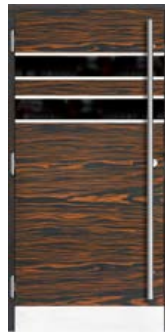

P88 – page 29



P89 – page 14



P90 – page 14

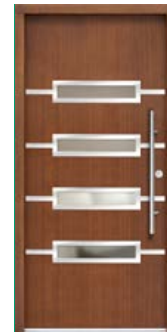

P91 – page 13



P92 – page 23



P93 – page 19



P94 – page 23



P95 – page 14



P96 – page 28



P97 – page 16



P98 – page 12



P99 – page 13



P100 – page 15



P101 – page 15



P102 – page 14



P103 – page 14



P104 – page 15



P105 – page 15



P106 – page 12

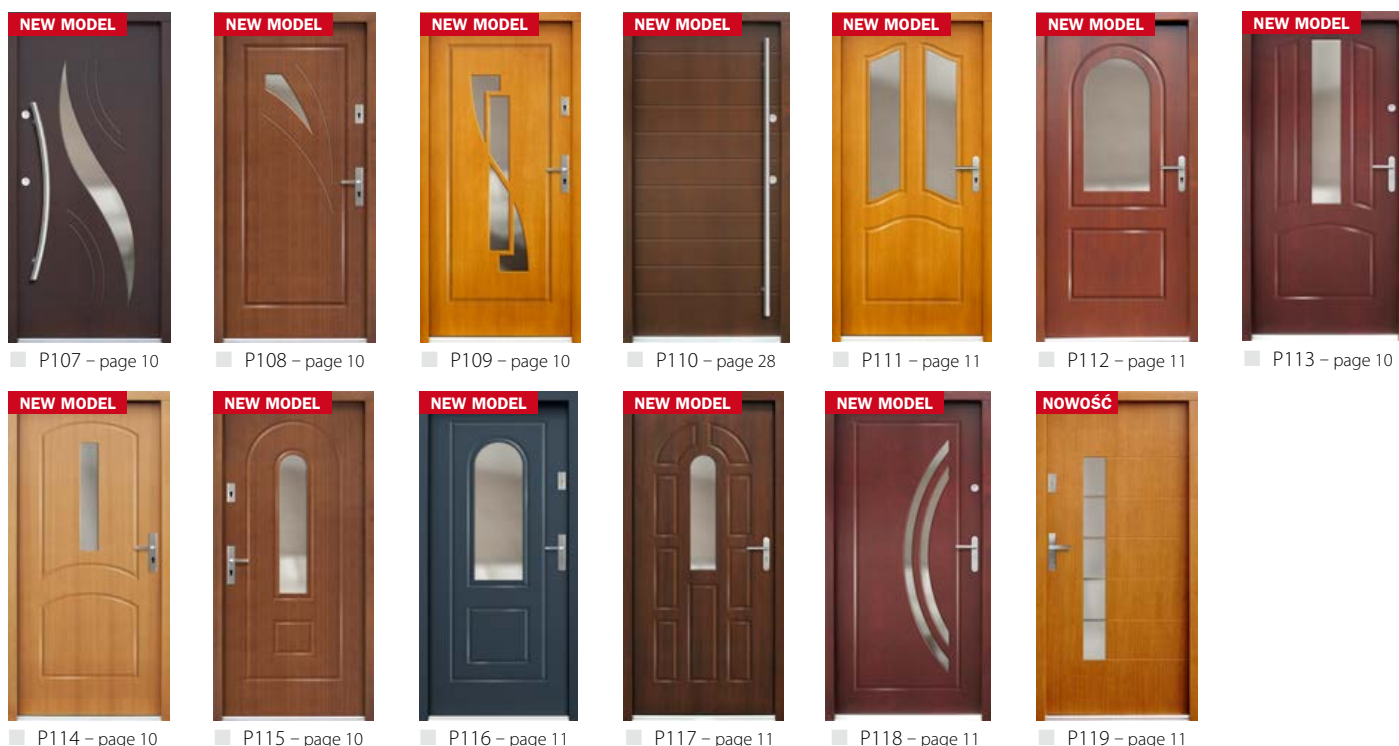

TYPES OF APPLICABLE GLAZING [REFLEX SET IN STANDARD]

ANTISOL

It is visor glass, delicately tinted brown that decreases the permeability of solar energy. Thanks to this, it prevents interiors from heating up. What is more, it protects the objects sensitive to UV light.

REFLEX [STOPSOL]

It is the glass of enhanced sun light control. It improves visual effect and gives a feeling of privacy. This effect is the result of applying metal oxides on one side of glass. People looking at the glass from the brighter side of mirror see their reflexion and are visible to people being on the darker side. Only when approaching the glass closely from the brighter side one can notice objects on the darker side.

TWO-WAY MIRROR [PHOENICIAN]

It is glass covered on both sides with metal oxides. Usually it is exploited as the partition between the rooms one of which is darkened. People staying on the lighter side of the mirror can see their own reflexion and are visible to people staying on the darker side.

MILK GLASS

It is glass that is covered with satin-frosted lacquer thanks to which it allows light through but becomes opaque.

ANTIBURGLARY GLASS P4

It consists of two layers of colourless glass between which there is antiburglary foil. Thanks to the foil, in case of hitting the glass, it breaks into tiny pieces and at the very place of contact the cracks go stellately. P4 glass is available only as transparent.

SECURE GLASS 331

It is glass that reduces to minimum the health risk for people staying in glazed rooms. The risk can include the shards of broken glass as well as fire, gas or heat radiation - symptoms of fire. The glass is called 'secure' provided that the technology of its production or connections allow for reducing damage resulting from possible deformation, impact or fire. The mark 331 stands for the glazing consisting of two sheets of glass, each 3 mm thick, and one layer of foil. Secure glass 331 belongs to the 02 grade glass. It is most often used in apartments, schools, offices. It guarantees protection against injuries and also can be applied in the buildings vulnerable to interior explosion threat.

SANDBLASTED GLASS

It is glass that undergoes the mechanical process of frosting by means of sand blasting under high pressure. This process enables to decorate the glass with any pattern available in our catalogue or individual projects provided by the Client. The final effect can be frosted pattern or reversely - smart transparent design.

COLLECTION OF EXTERIOR DOORS



NEW MODEL

72 mm Pine, Oak, Meranti
82 mm Pine, Oak, Meranti
102 mm Oak, Meranti

P107

holder is additionally charged



NEW MODEL

72 mm Pine, Oak, Meranti
82 mm Pine, Oak, Meranti
102 mm Oak, Meranti

P108



NEW MODEL

72 mm Pine, Oak, Meranti
82 mm Pine, Oak, Meranti
102 mm Oak, Meranti

P109



NEW MODEL

72 mm Pine, Oak, Meranti
82 mm Pine, Oak, Meranti
102 mm Oak, Meranti

P113



NEW MODEL

72 mm Pine, Oak, Meranti
82 mm Pine, Oak, Meranti
102 mm Oak, Meranti

P114



NEW MODEL

72 mm Pine, Oak, Meranti
82 mm Pine, Oak, Meranti
102 mm Oak, Meranti

P115

ERKADO doors are available in non-standard dimensions without the charge for non-typical dimension.
The additional charge concerns only doors: higher than 210 cm and wider than 102 cm (in thickness 72 mm and 82 mm)



72 mm Pine, Oak, Meranti
82 mm Pine, Oak, Meranti
102 mm Oak, Meranti

P119
SANDBLASTED GLASS



72 mm Pine, Oak, Meranti
82 mm Pine, Oak, Meranti
102 mm Oak, Meranti

P111



72 mm Pine, Oak, Meranti
82 mm Pine, Oak, Meranti
102 mm Oak, Meranti

P112



72 mm Pine, Oak, Meranti
82 mm Pine, Oak, Meranti
102 mm Oak, Meranti

P116



72 mm Pine, Oak, Meranti
82 mm Pine, Oak, Meranti
102 mm Oak, Meranti

P117



72 mm Pine, Oak, Meranti
82 mm Pine, Oak, Meranti
102 mm Oak, Meranti

P118

ERKADO doors are available in non-standard dimensions without the charge for non-typical dimension.
The additional charge concerns only doors: higher than 210 cm and wider than 102 cm (in thickness 72 mm and 82 mm)

COLLECTION OF EXTERIOR DOORS



72 mm Pine, Oak, Meranti
82 mm Pine, Oak, Meranti
102 mm Oak, Meranti

P42
both side inox stainless iron sheet
is additionally charged



72 mm Pine, Oak, Meranti
82 mm Pine, Oak, Meranti
102 mm Oak, Meranti

P98
additionally charged:
holder, double colour, version with glazing,
both side inox stainless iron sheet



72 mm Pine, Oak, Meranti
82 mm Pine, Oak, Meranti
102 mm Oak, Meranti

P48
both side inox stainless iron sheet
is additionally charged



72 mm Pine, Oak, Meranti
82 mm Pine, Oak, Meranti
102 mm Oak, Meranti

P70
both side inox stainless iron sheet
is additionally charged



72 mm Pine, Oak, Meranti
82 mm Pine, Oak, Meranti
102 mm Oak, Meranti

P57
additionally charged:
both side inox stainless iron sheet
double colour



72 mm Pine, Oak, Meranti
82 mm Pine, Oak, Meranti
102 mm Oak, Meranti

P106
additionally charged:
both side inox stainless iron sheet,
holder,
version with glazing

ERKADO doors are available in non-standard dimensions without the charge for non-typical dimension.
The additional charge concerns only doors: higher than 210 cm and wider than 102 cm (in thickness 72 mm and 82 mm)



72 mm Pine, Oak, Meranti
82 mm Pine, Oak, Meranti
102 mm Oak, Meranti



P99

additionally charged:
both side inox stainless iron sheet,
version with glazing

72 mm Pine, Oak, Meranti
82 mm Pine, Oak, Meranti
102 mm Oak, Meranti



P60

both side inox stainless iron sheet
is additionally charged

72 mm Pine, Oak, Meranti
82 mm Pine, Oak, Meranti
102 mm Oak, Meranti



P68

both side inox stainless iron sheet
is additionally charged

72 mm Pine, Oak, Meranti
82 mm Pine, Oak, Meranti
102 mm Oak, Meranti



P44

additionally charged:
both side inox stainless iron sheet,
holder

ATTENTION:

P44 doors are available only with multi-point
lock with 1 cylinder and double-side holder

72 mm Pine, Oak, Meranti
82 mm Pine, Oak, Meranti
102 mm Oak, Meranti



P91

additionally charged:
both side inox stainless iron sheet,
holder

72 mm Pine, Oak, Meranti
82 mm Pine, Oak, Meranti
102 mm Oak, Meranti



P81

both side inox stainless iron sheet
is additionally charged

ERKADO doors are available in non-standard dimensions without the charge for non-typical dimension.
The additional charge concerns only doors: higher than 210 cm and wider than 102 cm (in thickness 72 mm and 82 mm)

COLLECTION OF EXTERIOR DOORS



72 mm Pine, Oak, Meranti
82 mm Pine, Oak, Meranti
102 mm Oak, Meranti

P66

additionally charged:
both side inox stainless iron sheet,
version with glazing



72 mm Pine, Oak, Meranti
82 mm Pine, Oak, Meranti
102 mm Oak, Meranti

P89

both side inox stainless iron sheet
is additionally charged



72 mm Pine, Oak, Meranti
82 mm Pine, Oak, Meranti
102 mm Oak, Meranti

P90

both side inox stainless iron sheet
is additionally charged



72 mm Pine, Oak, Meranti
82 mm Pine, Oak, Meranti
102 mm Oak, Meranti

P103

additionally charged:
both side inox stainless iron sheet,
version with glazing



72 mm Pine, Oak, Meranti
82 mm Pine, Oak, Meranti
102 mm Oak, Meranti

P102

both side inox stainless iron sheet
is additionally charged



72 mm Pine, Oak, Meranti
82 mm Pine, Oak, Meranti
102 mm Oak, Meranti

P95

additionally charged:
both side inox stainless iron sheet,
version with glazing

ERKADO doors are available in non-standard dimensions without the charge for non-typical dimension.
The additional charge concerns only doors: higher than 210 cm and wider than 102 cm (in thickness 72 mm and 82 mm)



72 mm Pine, Oak, Meranti
82 mm Pine, Oak, Meranti
102 mm Oak, Meranti



P101
both side inox stainless iron sheet
is additionally charged

72 mm Pine, Oak, Meranti
82 mm Pine, Oak, Meranti
102 mm Oak, Meranti



P82
version with glazing is additionally charged

72 mm Pine, Oak, Meranti
82 mm Pine, Oak, Meranti
102 mm Oak, Meranti



P104
additionally charged:
both side inox stainless iron sheet,
bottom stainless steel kick plate
holder

72 mm Pine, Oak, Meranti
82 mm Pine, Oak, Meranti
102 mm Oak, Meranti



P46
additionally charged:
both side inox stainless iron sheet,
holder

72 mm Pine, Oak, Meranti
82 mm Pine, Oak, Meranti
102 mm Oak, Meranti



P105
both side inox stainless iron sheet
is additionally charged

72 mm Pine, Oak, Meranti
82 mm Pine, Oak, Meranti
102 mm Oak, Meranti



P100
both side inox stainless iron sheet
is additionally charged

ERKADO doors are available in non-standard dimensions without the charge for non-typical dimension.
The additional charge concerns only doors: higher than 210 cm and wider than 102 cm (in thickness 72 mm and 82 mm)

COLLECTION OF EXTERIOR DOORS



72 mm Pine, Oak, Meranti
82 mm Pine, Oak, Meranti
102 mm Oak, Meranti

P58
both side inox stainless iron sheet is additionally charged



72 mm Pine, Oak, Meranti
82 mm Pine, Oak, Meranti
102 mm Oak, Meranti

P97
both side inox stainless iron sheet is additionally charged
holder is additionally charged
version with glazing is additionally charged



72 mm Pine, Oak, Meranti
82 mm Pine, Oak, Meranti
102 mm Oak, Meranti

P56
both side inox stainless iron sheet is additionally charged



72 mm Pine, Oak, Meranti
82 mm Pine, Oak, Meranti
102 mm Oak, Meranti

P84
version with glazing is additionally charged



72 mm Pine, Oak, Meranti
82 mm Pine, Oak, Meranti
102 mm Oak, Meranti

P83
version with glazing is additionally charged

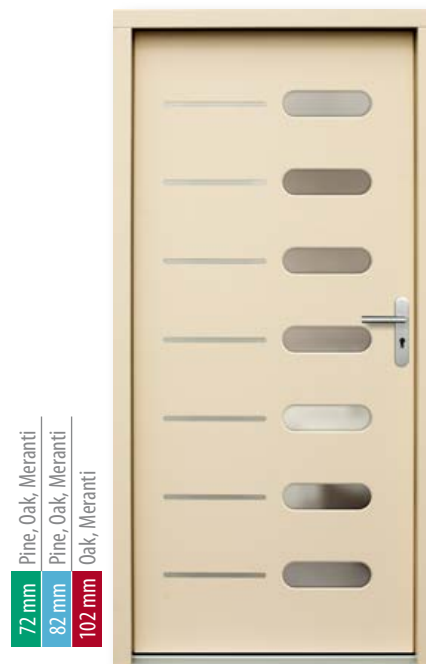

72 mm Pine, Oak, Meranti
82 mm Pine, Oak, Meranti
102 mm Oak, Meranti

P64
both side inox stainless iron sheet is additionally charged

ERKADO doors are available in non-standard dimensions without the charge for non-typical dimension.
The additional charge concerns only doors: higher than 210 cm and wider than 102 cm (in thickness 72 mm and 82 mm)



72 mm Pine, Oak, Meranti
82 mm Pine, Oak, Meranti
102 mm Oak, Meranti

■ P75



72 mm Pine, Oak, Meranti
82 mm Pine, Oak, Meranti
102 mm Oak, Meranti

■ P61



72 mm Pine, Oak, Meranti
82 mm Pine, Oak, Meranti
102 mm Oak, Meranti

■ P76



72 mm Pine, Oak, Meranti
82 mm Pine, Oak, Meranti
102 mm Oak, Meranti

■ P73



72 mm Pine, Oak, Meranti
82 mm Pine, Oak, Meranti
102 mm Oak, Meranti

■ P74



72 mm Pine, Oak, Meranti
82 mm Pine, Oak, Meranti
102 mm Oak, Meranti

■ P62

ERKADO doors are available in non-standard dimensions without the charge for non-typical dimension.
The additional charge concerns only doors: higher than 210 cm and wider than 102 cm (in thickness 72 mm and 82 mm)

COLLECTION OF EXTERIOR DOORS



72 mm Pine, Oak, Meranti
82 mm Pine, Oak, Meranti
102 mm Oak, Meranti

P8

version with glazing is additionally charged



72 mm Pine, Oak, Meranti
82 mm Pine, Oak, Meranti
102 mm Oak, Meranti

P9

version with glazing is additionally charged



72 mm Pine, Oak, Meranti
82 mm Pine, Oak, Meranti
102 mm Oak, Meranti

P21

version with glazing is additionally charged



72 mm Pine, Oak, Meranti
82 mm Pine, Oak, Meranti
102 mm Oak, Meranti

P47



72 mm Pine, Oak, Meranti
82 mm Pine, Oak, Meranti
102 mm Oak, Meranti

P37

version with glazing is additionally charged



72 mm Pine, Oak, Meranti
82 mm Pine, Oak, Meranti
102 mm Oak, Meranti

P10

ERKADO doors are available in non-standard dimensions without the charge for non-typical dimension.
The additional charge concerns only doors: higher than 210 cm and wider than 102 cm (in thickness 72 mm and 82 mm)



72 mm Pine, Oak, Meranti
 82 mm Pine, Oak, Meranti
 102 mm Oak, Meranti



■ P24

72 mm Pine, Oak, Meranti
 82 mm Pine, Oak, Meranti
 102 mm Oak, Meranti



■ P25

72 mm Pine, Oak, Meranti
 82 mm Pine, Oak, Meranti
 102 mm Oak, Meranti



■ P40

72 mm Pine, Oak, Meranti
 82 mm Pine, Oak, Meranti
 102 mm Oak, Meranti



■ P72

72 mm Pine, Oak, Meranti
 82 mm Pine, Oak, Meranti
 102 mm Oak, Meranti



■ P28

72 mm Pine, Oak, Meranti
 82 mm Pine, Oak, Meranti
 102 mm Oak, Meranti



■ P93

version with glazing is additionally charged

ERKADO doors are available in non-standard dimensions without the charge for non-typical dimension. The additional charge concerns only doors: higher than 210 cm and wider than 102 cm (in thickness 72 mm and 82 mm)

COLLECTION OF EXTERIOR DOORS



72 mm Pine, Oak, Meranti
82 mm Pine, Oak, Meranti
102 mm Oak, Meranti

■ P77



72 mm Pine, Oak, Meranti
82 mm Pine, Oak, Meranti
102 mm Oak, Meranti

■ P67

version with glazing is additionally charged



72 mm Pine, Oak, Meranti
82 mm Pine, Oak, Meranti
102 mm Oak, Meranti

■ P79

version with glazing is additionally charged



72 mm Pine, Oak, Meranti
82 mm Pine, Oak, Meranti
102 mm Oak, Meranti

■ P63



72 mm Pine, Oak, Meranti
82 mm Pine, Oak, Meranti
102 mm Oak, Meranti

■ P65



72 mm Pine, Oak, Meranti
82 mm Pine, Oak, Meranti
102 mm Oak, Meranti

■ P20

ERKADO doors are available in non-standard dimensions without the charge for non-typical dimension.
The additional charge concerns only doors: higher than 210 cm and wider than 102 cm (in thickness 72 mm and 82 mm)



72 mm Pine, Oak, Meranti
82 mm Pine, Oak, Meranti
102 mm Oak, Meranti



■ P51

72 mm Pine, Oak, Meranti
82 mm Pine, Oak, Meranti
102 mm Oak, Meranti



■ P30

72 mm Pine, Oak, Meranti
82 mm Pine, Oak, Meranti
102 mm Oak, Meranti



■ P39

72 mm Pine, Oak, Meranti
82 mm Pine, Oak, Meranti
102 mm Oak, Meranti



■ P52

72 mm Pine, Oak, Meranti
82 mm Pine, Oak, Meranti
102 mm Oak, Meranti



■ P23

version with glazing is additionally charged

72 mm Pine, Oak, Meranti
82 mm Pine, Oak, Meranti
102 mm Oak, Meranti



■ P49

ERKADO doors are available in non-standard dimensions without the charge for non-typical dimension.
The additional charge concerns only doors: higher than 210 cm and wider than 102 cm (in thickness 72 mm and 82 mm)

COLLECTION OF EXTERIOR DOORS

72 mm Pine, Oak, Meranti
82 mm Pine, Oak, Meranti
102 mm Oak, Meranti



P53
Version with glazing is additionally charged

72 mm Pine, Oak, Meranti
82 mm Pine, Oak, Meranti
102 mm Oak, Meranti



P41
AVAILABLE ONLY IN RAL COLOURS

72 mm Pine, Oak, Meranti
82 mm Pine, Oak, Meranti
102 mm Oak, Meranti



P32

72 mm Pine, Oak, Meranti
82 mm Pine, Oak, Meranti
102 mm Oak, Meranti



P36

72 mm Pine, Oak, Meranti
82 mm Pine, Oak, Meranti
102 mm Oak, Meranti



P29

72 mm Pine, Oak, Meranti
82 mm Pine, Oak, Meranti
102 mm Oak, Meranti



P19

ERKADO doors are available in non-standard dimensions without the charge for non-typical dimension.
The additional charge concerns only doors: higher than 210 cm and wider than 102 cm (in thickness 72 mm and 82 mm)

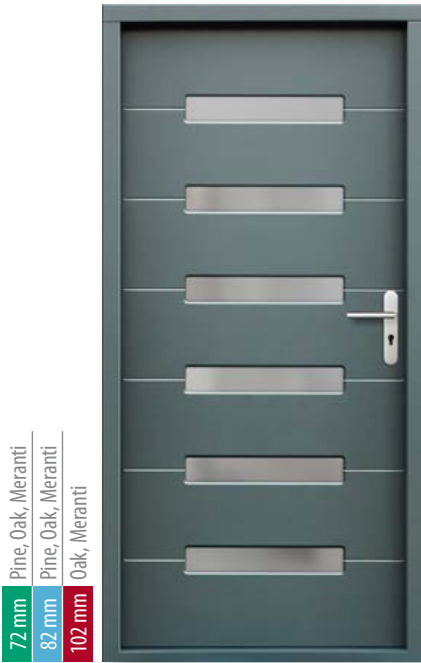

72 mm Pine, Oak, Meranti
82 mm Pine, Oak, Meranti
102 mm Oak, Meranti

■ P55



72 mm Pine, Oak, Meranti
82 mm Pine, Oak, Meranti
102 mm Oak, Meranti

■ P94



72 mm Pine, Oak, Meranti
82 mm Pine, Oak, Meranti
102 mm Oak, Meranti

■ P92



72 mm Pine, Oak, Meranti
82 mm Pine, Oak, Meranti
102 mm Oak, Meranti

■ P71



72 mm Pine, Oak, Meranti
82 mm Pine, Oak, Meranti
102 mm Oak, Meranti

■ P69



72 mm Pine, Oak, Meranti
82 mm Pine, Oak, Meranti
102 mm Oak, Meranti

■ P7

ERKADO doors are available in non-standard dimensions without the charge for non-typical dimension.
The additional charge concerns only doors: higher than 210 cm and wider than 102 cm (in thickness 72 mm and 82 mm)

COLLECTION OF EXTERIOR DOORS



72 mm Pine, Oak, Meranti
82 mm Pine, Oak, Meranti
102 mm Oak, Meranti

■ P80



72 mm Pine, Oak, Meranti
82 mm Pine, Oak, Meranti
102 mm Oak, Meranti

■ P54



72 mm Pine, Oak, Meranti
82 mm Pine, Oak, Meranti
102 mm Oak, Meranti

■ P22



72 mm Pine, Oak, Meranti
82 mm Pine, Oak, Meranti
102 mm Oak, Meranti

■ P78



72 mm Pine, Oak, Meranti
82 mm Pine, Oak, Meranti
102 mm Oak, Meranti

■ P34



72 mm Pine, Oak, Meranti
82 mm Pine, Oak, Meranti
102 mm Oak, Meranti

■ P31

ERKADO doors are available in non-standard dimensions without the charge for non-typical dimension.
The additional charge concerns only doors: higher than 210 cm and wider than 102 cm (in thickness 72 mm and 82 mm)



72 mm Pine, Oak, Meranti
82 mm Pine, Oak, Meranti
102 mm Oak, Meranti

P13



72 mm Pine, Oak, Meranti
82 mm Pine, Oak, Meranti
102 mm Oak, Meranti

P14



72 mm Pine, Oak, Meranti
82 mm Pine, Oak, Meranti
102 mm Oak, Meranti

P27

version with glazing is additionally charged



72 mm Pine, Oak, Meranti
82 mm Pine, Oak, Meranti
102 mm Oak, Meranti

P12



72 mm Pine, Oak, Meranti
82 mm Pine, Oak, Meranti
102 mm Oak, Meranti

P26



72 mm Pine, Oak, Meranti
82 mm Pine, Oak, Meranti
102 mm Oak, Meranti

P6

ERKADO doors are available in non-standard dimensions without the charge for non-typical dimension. The additional charge concerns only doors: higher than 210 cm and wider than 102 cm (in thickness 72 mm and 82 mm)

COLLECTION OF EXTERIOR DOORS

72 mm Pine, Oak, Meranti
82 mm Pine, Oak, Meranti
102 mm Oak, Meranti



■ P5

72 mm Pine, Oak, Meranti
82 mm Pine, Oak, Meranti
102 mm Oak, Meranti



■ P3

72 mm Pine, Oak, Meranti
82 mm Pine, Oak, Meranti
102 mm Oak, Meranti



■ P45

72 mm Pine, Oak, Meranti
82 mm Pine, Oak, Meranti
102 mm Oak, Meranti



■ P50

72 mm Pine, Oak, Meranti
82 mm Pine, Oak, Meranti
102 mm Oak, Meranti



■ P33

72 mm Pine, Oak, Meranti
82 mm Pine, Oak, Meranti
102 mm Oak, Meranti



■ P16

ERKADO doors are available in non-standard dimensions without the charge for non-typical dimension.
The additional charge concerns only doors: higher than 210 cm and wider than 102 cm (in thickness 72 mm and 82 mm)



72 mm Pine, Oak, Meranti
82 mm Pine, Oak, Meranti
102 mm Oak, Meranti

■ P4



72 mm Pine, Oak, Meranti
82 mm Pine, Oak, Meranti
102 mm Oak, Meranti

■ P1



72 mm Pine, Oak, Meranti
82 mm Pine, Oak, Meranti
102 mm Oak, Meranti

■ P11



72 mm Pine, Oak, Meranti
82 mm Pine, Oak, Meranti
102 mm Oak, Meranti

■ P2



72 mm Pine, Oak, Meranti
82 mm Pine, Oak, Meranti
102 mm Oak, Meranti

■ P15



72 mm Pine, Oak, Meranti
82 mm Pine, Oak, Meranti
102 mm Oak, Meranti

■ P35

ERKADO doors are available in non-standard dimensions without the charge for non-typical dimension.
The additional charge concerns only doors: higher than 210 cm and wider than 102 cm (in thickness 72 mm and 82 mm)

COLLECTION OF EXTERIOR DOORS



72 mm Pine, Oak, Meranti
82 mm Pine, Oak, Meranti
102 mm Oak, Meranti

■ P38



72 mm Pine, Oak, Meranti
82 mm Pine, Oak, Meranti
102 mm Oak, Meranti

■ P59



72 mm Pine, Oak, Meranti
82 mm Pine, Oak, Meranti
102 mm Oak, Meranti

■ P96



72 mm Pine, Oak, Meranti
82 mm Pine, Oak, Meranti
102 mm Oak, Meranti

■ P18



72 mm Pine, Oak, Meranti
82 mm Pine, Oak, Meranti
102 mm Oak, Meranti

■ P17



72 mm Pine, Oak, Meranti
82 mm Pine, Oak, Meranti
102 mm Oak, Meranti

■ P110

holder is additionally charged

ERKADO doors are available in non-standard dimensions without the charge for non-typical dimension.
The additional charge concerns only doors: higher than 210 cm and wider than 102 cm (in thickness 72 mm and 82 mm)

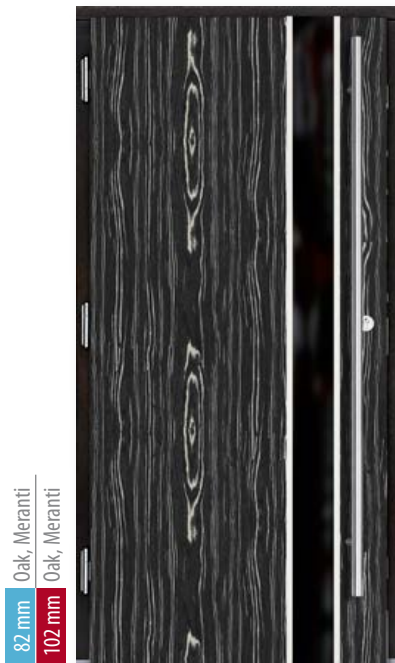

82 mm Oak, Meranti
102 mm Oak, Meranti

P85
holder is additionally charged



82 mm Oak, Meranti
102 mm Oak, Meranti

P86

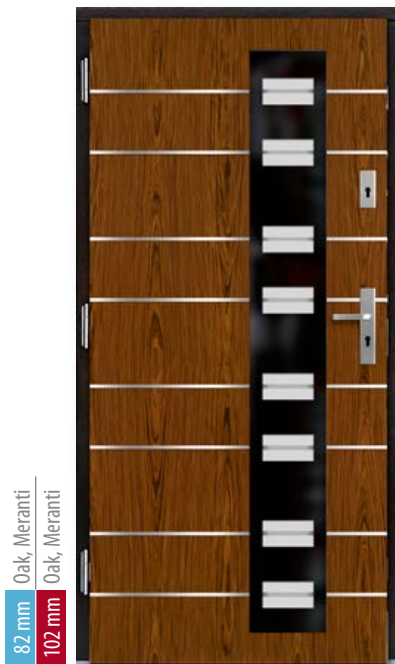

82 mm Oak, Meranti
102 mm Oak, Meranti

P87



82 mm Oak, Meranti
102 mm Oak, Meranti

P88
holder is additionally charged

MASKAR EBONY



BLACK&WHITE EBONY

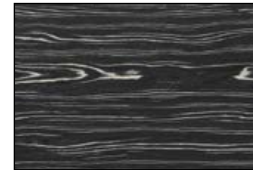

BURMA TEAK



MADAGASKAR ROSEWOOD



- the above decors come only on one side
- decors with glass and stainless steel appear on the exterior side of door leaf
- available only 4 types of veneer:
MASKAR EBONY
BLACK&WHITE EBONY
MADAGASKAR ROSEWOOD
BURMA TEAK
- mahogany frame painted rosewood

EXPANSION CAPABILITIES

The modern and classical collection of ERKADO exterior doors can be expanded by constructing accordant and compatible sidelights and toplights as well as side door leaves. Their design and price are quoted individually.



P37 + FIXED SIDE DOOR LEAF [IMITATING DOOR LEAF]

Door width (cm)	Door height (cm)	
	with aluminium threshold	with wooden threshold
160	208,2	210



P82 + FIXED SIDE DOOR LEAF [IMITATING DOOR LEAF]

Door width (cm)	Door height with wooden threshold (cm)
160	210



P99 + FIXED SIDE DOOR LEAF [IMITATING DOOR LEAF]

Door width (cm)	Door height (cm)	
	with aluminium threshold	with wooden threshold
160	208,2	210



P105 + FIXED GLASS IN-FRAME SIDE DOOR LEAF

Door width (cm)	Door height (cm)	
	with aluminium threshold	with wooden threshold
160	208,2	210

ERKADO doors are available in non-standard dimensions without the charge for non-typical dimension. The additional charge concerns only doors: higher than 210 cm and wider than 102 cm (in thickness 72 mm and 82 mm)



P67 + FIXED SIDE DOOR LEAF [IMITATING DOOR LEAF]

Door width (cm)	Door height (cm)	
	with aluminium threshold	with wooden threshold
160	208,2	210



P89 + FIXED SIDE DOOR LEAF [IMITATING DOOR LEAF]

Door width (cm)	Door height (cm)	
	with aluminium threshold	with wooden threshold
160	208,2	210



P65 + FIXED SIDE DOOR LEAF [IMITATING DOOR LEAF]

Door width (cm)	Door height (cm)	
	with aluminium threshold	with wooden threshold
160	208,2	210



P25 + FIXED SIDE DOOR LEAF [IMITATING DOOR LEAF]

Door width (cm)	Door height (cm)	
	with aluminium threshold	with wooden threshold
160	208,2	210

ERKADO doors are available in non-standard dimensions without the charge for non-typical dimension. The additional charge concerns only doors: higher than 210 cm and wider than 102 cm (in thickness 72 mm and 82 mm)

EXPANSION CAPABILITIES



P9 + FIXED SIDE DOOR LEAF [IMITATING DOOR LEAF]

Door width (cm)	Door height (cm)	
	with aluminium threshold	with wooden threshold
160	208,2	210



P47 + OPENING GLASS SIDE DOOR LEAF

Door width (cm)	Door height with wooden threshold (cm)
160	210



P21 + FIXED SIDE DOOR LEAF [IMITATING DOOR LEAF]

Door width (cm)	Door height (cm)	
	with aluminium threshold	with wooden threshold
160	208,2	210



P55 + FIXED GLASS IN-FRAME SIDE DOOR LEAF

Door width (cm)	Door height (cm)	
	with aluminium threshold	with wooden threshold
140	208,2	210

ERKADO doors are available in non-standard dimensions without the charge for non-typical dimension. The additional charge concerns only doors: higher than 210 cm and wider than 102 cm (in thickness 72 mm and 82 mm)

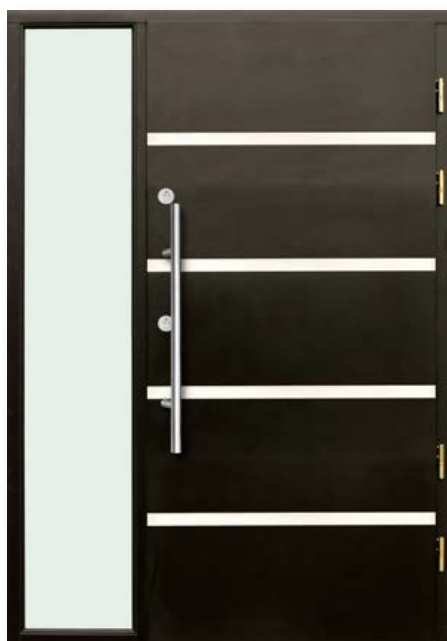

P46 + FIXED GLASS IN-FRAME SIDE DOOR LEAF

Door width (cm)	Door height (cm)	
	with aluminium threshold	with wooden threshold
140	208,2	210



P44 + FIXED GLASS IN-FRAME SIDE DOOR LEAFS

Door width (cm)	Door height (cm)	
	with aluminium threshold	with wooden threshold
180	208,2	210



P45 + FIXED GLASS IN-FRAME SIDE DOOR LEAFS

Door width (cm)	Door height (cm)	
	with aluminium threshold	with wooden threshold
160	208,2	210

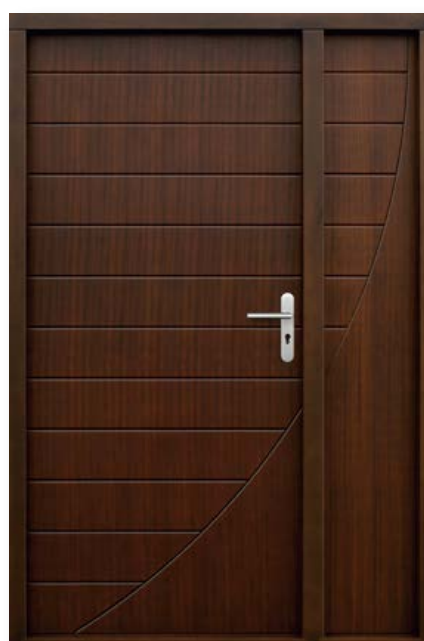

P59 + FIXED SIDE DOOR LEAF [IMITATING DOOR LEAF]

Door width (cm)	Door height (cm)	
	with aluminium threshold	with wooden threshold
140	208,2	210

ATTENTION: fixed in-frame side door leaf
– glazing – secure glass set 44 mm REFLEX BROWN

ERKADO doors are available in non-standard dimensions without the charge for non-typical dimension.
The additional charge concerns only doors: higher than 210 cm and wider than 102 cm (in thickness 72 mm and 82 mm)

EXPANSION CAPABILITIES



P42 + FIXED SIDE DOOR LEAF [IMITATING DOOR LEAF] + TOP LIGHT

Door width (cm)	Door height (cm)	
	with aluminium threshold	with wooden threshold
160	240	240



P28 + FIXED SIDE DOOR LEAF [IMITATING DOOR LEAF] + TOP LIGHT

Door width (cm)	Door height (cm)	
	with aluminium threshold	with wooden threshold
180	240	240



P34 + FIXED GLASS SIDE DOOR LEAFS [IMITATING DOOR LEAF]

Door width (cm)	Door height (cm)	
	with aluminium threshold	with wooden threshold
190	208,2	210



P28 + FIXED SIDE DOOR LEAF [IMITATING DOOR LEAF]

Door width (cm)	Door height (cm)	
	with aluminium threshold	with wooden threshold
140	208,2	210

ERKADO doors are available in non-standard dimensions without the charge for non-typical dimension. The additional charge concerns only doors: higher than 210 cm and wider than 102 cm (in thickness 72 mm and 82 mm)

Attention: fixed side door leaf is fitted on the hinges

TECHNICAL PARAMETRES

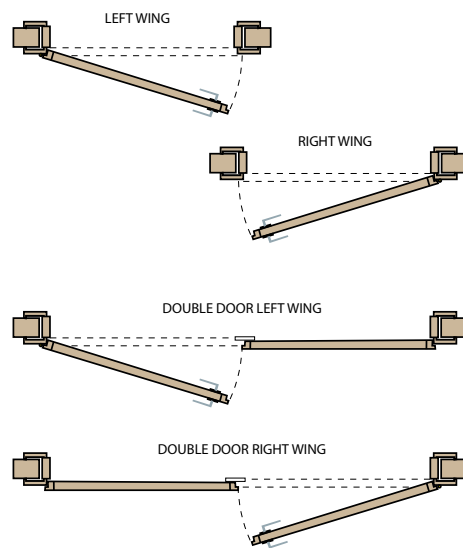
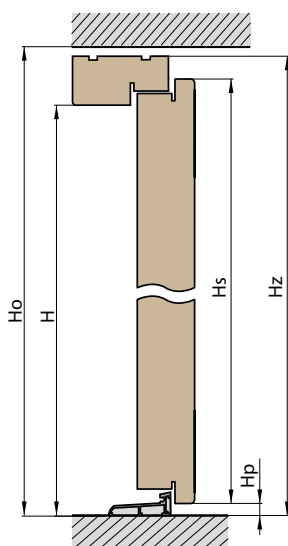
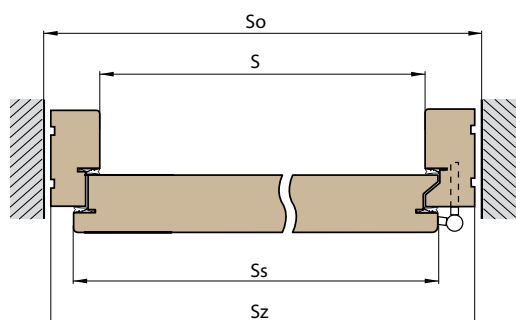

S – clear frame opening width [mm]
So – wall hole width [mm]
Ss – door leaf width [mm]
Sz – total door leaf width [mm]
Ho – wall hole height [mm]

H – clear frame opening height [mm]
Hs – door leaf height [mm]
Hz – total door height [mm]
Hpa – aluminium threshold height [mm]
Hpd – wooden threshold height [mm]

TECHNICAL DATA

DIMENSIONS WITH ALUMINIUM THRESHOLD

Leaf thickness	Size	S	So	Ss	Sz	H	Ho	Hs	Hz	Hpa ALU (aluminium threshold)
72 mm 82 mm	„80“	800	940	835	920	2002	2100	2035	2082	20
	„90“	900	1040	935	1020	2002	2100	2035	2082	20
	„100“	1000	1140	1035	1120	2002	2100	2035	2082	20
102 mm	„80“	800	980	865	960	2002	2120	2050	2102	20
	„90“	900	1080	965	1060	2002	2120	2050	2102	20
	„100“	1000	1180	1065	1160	2002	2120	2050	2102	20

DIMENSIONS WITH WOODEN THRESHOLD

Leaf thickness	Size	S	So	Ss	Sz	H	Ho	Hs	Hz	Hpd WOOD (wooden threshold)
72 mm 82 mm	„80“	800	940	835	920	2002	2120	2035	2100	40
	„90“	900	1040	935	1020	2002	2120	2035	2100	40
	„100“	1000	1140	1035	1120	2002	2120	2035	2100	40
102 mm	„80“	800	980	865	960	2002	2140	2050	2120	40
	„90“	900	1080	965	1060	2002	2140	2050	2120	40
	„100“	1000	1180	1065	1160	2002	2140	2050	2120	40

ADDITIONAL CHARGES FOR NONSTANDARD DOORS

ADDITIONAL CHARGES FOR NONSTANDARD DOORS	
No.	DESCRIPTION
1.	NO CHARGE FOR NARROWER DOOR LEAF
2.	CHARGE TO WIDER DOORS:
a)	door wider up to total width 106 cm [72 mm thick, 82 mm thick]
b)	door wider up to total width 110 cm [102 cm thick]
c)	door of total width from 107 cm to 111 cm [82 mm thick]
d)	door of total width from 111 cm to 115 cm [102 cm thick]
e)	charge to door 100 cm wide [112x208,2/210 - 72 mm thick and 82 mm thick], [116x210,2/212 - door 102 mm thick]
3.	3. CHARGE TO HIGHER DOORS [EXCLUDING TOPLIGHTS]:
a)	within scope from 208,2 cm up to 215 cm + 15% value of typical doors
b)	within scope from 215 cm up to 224 cm + 30% value of typical doors
4.	SIDE DOOR LEAF AT TOTAL WIDTH UP TO 150 cm
a)	open with glazing + 75% value of single door leaf
b)	open without glazing + 70% value of single door leaf
c)	fixed imitation of door leaf without glazing + 50% value of single door leaf
d)	fixed imitation of door leaf with glazing + 60% value of single door leaf
e)	fixed-in-frame mahogany-meranti (not depending on total width)
f)	fixed-in-frame oak (not depending on total width)
g)	fixed-in-frame pine (not depending on total width)
5.	SIDE DOOR LEAF AT TOTAL WIDTH FROM 150 UP TO 170 cm:
a)	open with glazing + 95% value of single door leaf
b)	open without glazing + 90% value of single door leaf
c)	fixed imitation with glazing + 85% value of single door leaf
d)	fixed imitation without glazing + 80% value of single door leaf
e)	fixed-in-frame mahogany-meranti (not depending on total width)
f)	fixed-in-frame oak (not depending on total width)
g)	fixed-in-frame pine (not depending on total width)
6.	ADDITIONAL CHARGE TO DOUBLE DOORS OF WIDTH FROM 171 cm TO 196 cm IS + 110 VALUE OF SINGLE DOOR LEAF
7.	FIXED DOOR LEAF AND TOPLIGHTS
a)	fixed-in-frame mahogany-meranti (not depending on total width)
b)	fixed-in-frame oak (not depending on total width)
c)	fixed-in-frame pine (not depending on total width)
d)	fixed imitation of door leaf up to total width 250 cm + 50% value of door leaf
8.	CHARGES - COLOUR
a)	Classic RAL Colour Palette [single door leaf], apart from RAL9016 [white] and RAL 7016 [charcoal]
b)	double-colour doors
9.	CHARGE FOR CHANGING GLAZING
a)	fixed charge for modification in glazing e.g. two-way mirror, milk glass, sanded glass, P4
10.	FRAME EXTENSION TO WALL WIDTH:
a)	mahogany-meranti material for each centimetre mahogany-meranti adjustable cover
b)	oak material for each centimetre oak adjustable cover
c)	pine material for each centimetre pine adjustable cover
11.	MASKING TRIMS 10 mm x 60 mm PER SET ON ONE SIDE
a)	mahogany-meranti
b)	oak
c)	pine
12.	QUARTER ROUNDS 10 mm x 25 mm PER SET ON ONE SIDE
a)	mahogany-meranti
b)	oak
c)	pine
13.	ALUMINIUM GUTTER DRIP DOORS OPENING INSIDE THICKNESS 82 mm AND 102 mm
a)	wooden gutter drip to doors opening inside thickness 72 mm

ACCESSORIES

■ CYLINDERS



■ PEEPHOLE



■ LOCKS

MULTI-POINT LOCK GU SECURITY AUTOMATIC

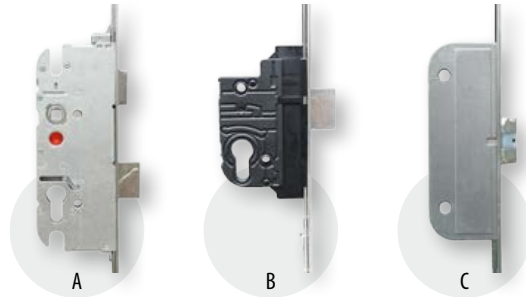

WHEN APPLYING MULTI-POINT LOCK THE EXTERIOR DOORS MEET THE REQUIREMENTS FOR SECOND CLASS RESISTANCE TO BURGLARY

MULTI-POINT LOCK WITH ONE CYLINDER
thickness 82 mm and 102 mm - standard
thickness 72 mm - charged

FOR TWO CYLINDERS
thickness 102 mm - charged
thickness 72 mm - charged

gr. 102 mm	cylinder class 'B' 65/60 universal
	cylinder class 'B' 65/60 with knob
	cylinder class 'C' 65/60 universal
	cylinder class 'B' 65/60 with knob
	cylinder 1-key system [2 pcs] class 'B' 65/60
	cylinder 1-key system [2 pcs] class 'C' 65/60
gr. 82 mm	cylinder class 'C' 65/45 universal
	cylinder class 'C' 65/45 with knob
	cylinder class 'B' 65/45 universal
	cylinder class 'B' 65/60 with knob
	cylinder 1-key system [2 pcs] class 'B' 65/45
	cylinder 1-key system [2 pcs] class 'C' 65/45
gr. 72mm	cylinder class 'B' 65/35
	cylinder class 'B' 65/35 universal
	cylinder class 'C' 65/35 with knob
	cylinder class 'C' 65/435 universal
	cylinder 1-key system [2 pcs] class 'B' 65/35
	cylinder 1-key system [2 pcs] class 'C' 65/35



TKZ HINGES
thickness 102 mm - standard
thickness 72 mm and 82 mm - charged

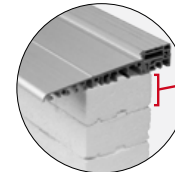

THERMOINSULATING STRIP
H: 30 mm x W: 64 mm
- extra charged

frame extension



F1 silver

F4 ancient gold

INOX

■ KNOBS

AXA



AXA KNOB AND FACE NIAGARA
colour F1 gloss



KNOB AND FACE ODIN
colour F3 gloss



KNOB AND FACE ROYAL
colour F1 gloss



AXA SOLO KNOB AND FACE
colour INOX gloss
(door knob and face to
one-side holders)



KNOB AND FACE HAGA
colour F1 gloss

TUPAI



TUPAI KNOB AND FACE 16
STAINLESS



F1 INOX F4

AXA HINGE CASINGS aluminium



IRON HINGE CASING TKZ
chrome gloss

casings for four hinges [set] aluminium Metal Bud [nickel, patina]
casings for four hinges [set] aluminium AXA [inox, F1, F4], or steel TKZ

METAL-BUD



ZEUS KNOB + face
nickel



ZEUS KNOB + face
patina

ACCESSORIES



OVERHEAD DOOR-CLOSER BY GEZE



ELECTRIC STRIKE

■ **By selecting doors with holder You can choose among three ways of opening:**

1. with key
2. with electric strike or key by day-night function
3. with button or key

■ **stainless holders**

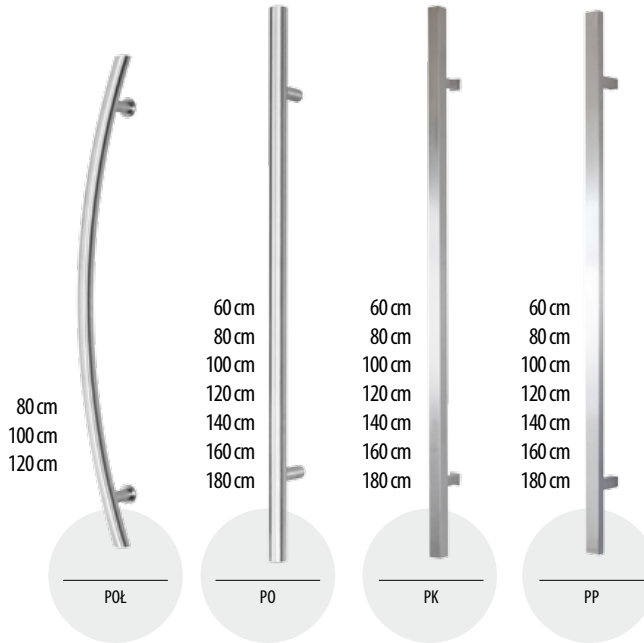

All holders can be equipped (extra charged) with a button function of door opening when installing electric strike.

■ **AXA aluminium holders**

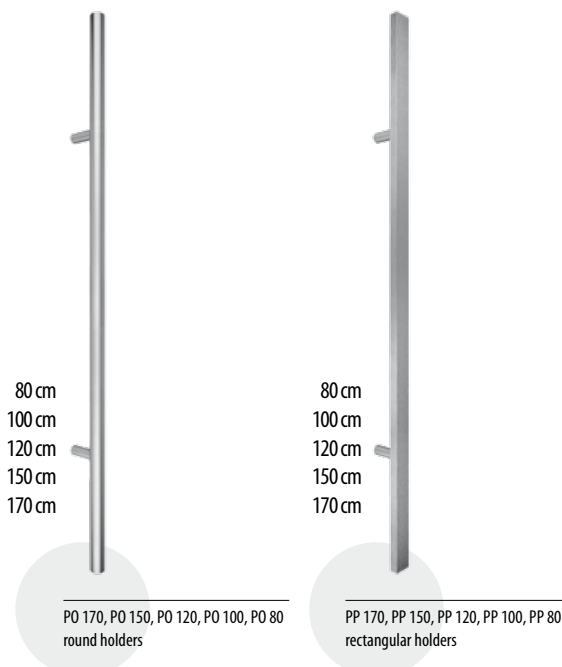

ASSEMBLY TYPES

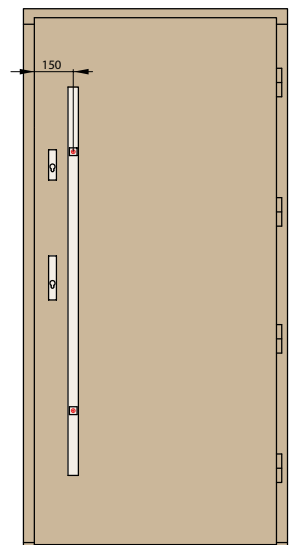

ASSEMBLY

ATTENTION:
Fixing one-side door holder is done with woodscrew.

ACCESSORIES

■ Electronic system of door opening

Bi-metric door lock is a contemporary solution thanks to which we do not have to be afraid of losing keys to our door.

Bio-metric lock operates with our fingerprints. The lock identifies the owner, or other person authorised to enter home, by scanning the fingerprints and comparing them to the patterns from database. The system can deposit and read 150 code patterns thanks to which all potential inhabitants may open the door without having a regular key.

Bio-metric locks are fully and highly secure. Fingerprints are unique and constant-coded and counterfeiting such a „key“ is not possible. Additionally, the reader of the lock does not store the fingerprints but a respective to them binary codes on the basis of which the pattern of fingerprints cannot be recreated.

Aside from standard option, bio-metric locks can be additionally connected to burglary alarm system.

The electronic system of door opening is quoted individually.



fingerprint reader



numeric keyboard

PROJECT FLEXIBILITY

DESIGN **YOUR OWN** EXTERIOR 'P' DOORS

Feel invited to design your own model of exterior P doors.

Technologies used by ERKADO allow to make practically all suggested patterns. Therefore it is possible to personalise Your own door preferences such as width [side doors], height [toplights], style, pattern [even the most sophisticated milling], colour [offered palette of colours and RAL colours].

Doors of personalised character are quoted individually.

Make your own exterior door with us!

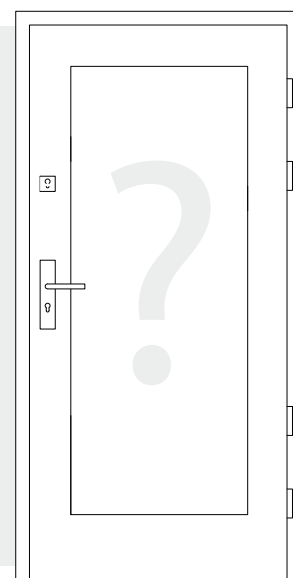



ERKADO Zbigniew Kozłowski

Chwałowice 156, 37-455 Radomyśl n/Sanem

NIP 865-118-29-63

e-mail: dz@erkado.pl

e-mail: drewno@erkado.pl

www.erkado.pl

EXTERIOR DOORS

tel. +48 15/ 845 33 88

fax +48 15/ 845 34 05

INTERIOR DOORS

tel. +48 15/ 838 10 57

fax +48 15/ 838 18 84

The guarantee and assembly cards are attached to the product.
This catalogue is only of the informative usage and includes up-to-date range of available products.

The producer has the right to change the prices and the range of available goods without official notification.

The colour samples can differ in reality with those presented in this catalogue. Please consult the colours with the original samples that can be accessed at our distributors.

We have the right to printing errors.

This catalogue does not constitute an offer, in the context of law and is published only for the informative purposes.

The choice of proper door leafs should be based on the technical project of the given space/room, worked upon with consideration of all legal housing norms and regulations being in law.

ERKADO offers several possibilities however the choice is left to the Purchaser due to the fact that only the Purchaser or person operating on Its behalf knows the purpose and exploitation conditions of the ordered product.

CE CERTIFICATE
FSC CERTIFICATE

Catalogue of exterior doors



Catalogue of interior doors



www.erkado.pl

 JOIN US ON:
www.facebook.com/ERKADO

Scan code and download this catalogue on to Your smatphone/tablet [pdf]